

For more information



FSEL	4	Switching frequency selection. Connecting to ground sets clock frequency to 400KHz. Floating sets clock frequency to 800KHz. Connecting to VCC sets clock frequency to 1.2MHz.
VOUT	5	VOUT is used to sense the output voltage of the buck regulator. Connect VOUT to the output capacitor of the regulator directly. Keep the VOUT sensing trace far away from the SW node. VIAs should also be avoided on the VOUT sensing trace. A trace larger than 25mil is required.
MODE	6	PFM, USM or FCCM mode selection. Connect the pin to VCC to force the device in Forced Continuous Current Modulation (FCCM) operation mode. Ground the pin to operate the device in Pulse Frequency Modulation (PFM) mode without Ultrasonic Mode (USM). Floating the pin to operate the device in PFM with USM.
SW	7	Connect SW to the inductor and bootstrap capacitor. SW is driven up to VIN through the high-side power MOSFET during on-time. The inductor current drives SW to negative voltage through low-side power MOSFET during off-time. Use wide and short PCB traces to make the connection. Keep the SW pattern area minimized.
BST	8	Bootstrap. Must connect a 0.1uF capacitor or greater between SW and BST to form a floating supply across the gate driver of high-side power MOSFET.
VCC	9	Internal VCC LDO output. The driver and control circuits are powered by VCC. Decouple with 1μF ceramic capacitor placed as close to VCC as possible.
AGND	10	Signal logic ground. AGND is the Kelvin connection to PGND.
FB	11	Feedback voltage Input. Connect FB to the tap of a resistor divider from output voltage to AGND to set up output voltage. The device regulates FB to the internal reference value of 0.6V typical.
EN	12	Enable logic input. EN is a digital input that controls the converter on or off. EN high turns on the device and EN low turns off the device. Connecting to VIN with a 100k pull-up resistor can enable the device. Floating EN pin automatically starts up the converter.

Over operating free-air temperature range unless otherwise noted

V _{IN}	Input voltage range	4.5	18	V
V _{OUT}	Output voltage range	0.6	7	V
T _J	Operating junction temperature	-40	125	°C

Human Body Model (HBM), per

V_{ESD}

(1) SCT provides R_{JA} and R_{JC} numbers only as reference to estimate junction temperatures of the devices. R_{JA} and R_{JC} are not a characteristic of package itself, but of many other system level characteristics such as the design and layout of the printed circuit board (PCB) on which the SCT2260A is mounted, thermal pad size, and external environmental factors. The PCB board is a heat sink that is soldered to the leads and thermal pad of the SCT2260A. Changing the design or configuration of the PCB board changes the efficiency of the heat sink and therefore the actual R_{JA} and R_{JC} .

$V_{IN}=12V$, $T_J=-40^{\circ}C\sim 125$

PG _{TD}	PG low to high delay		0.5	ms
V _{PG}	Power Good PG pull-down strength	I _{PG} =4mA	0.6	V
I _{PG_LEAK}	Power Good PG leakage current	V _{PG} =5V	5	uA
I _{LIM_P}	LS MOSFET positive current limit	From source to drain	7.5 8.5 9.5	A
I _{LIM_N}	LS MOSFET negative current limit	From drain to source, MODE connects to VCC	2.5	A
T _{HICCUP}	Hiccup waiting time		7	ms
V _{OVP_R}	V _{FB} OVP threshold % of V _{REF}	V _{FB} rising	122	%
V _{OVP_F}	V _{FB} OVP threshold % of V _{REF}	V _{FB} falling	117	%
V _{UVP_F}	V _{FB} UVP threshold % of V _{REF}			



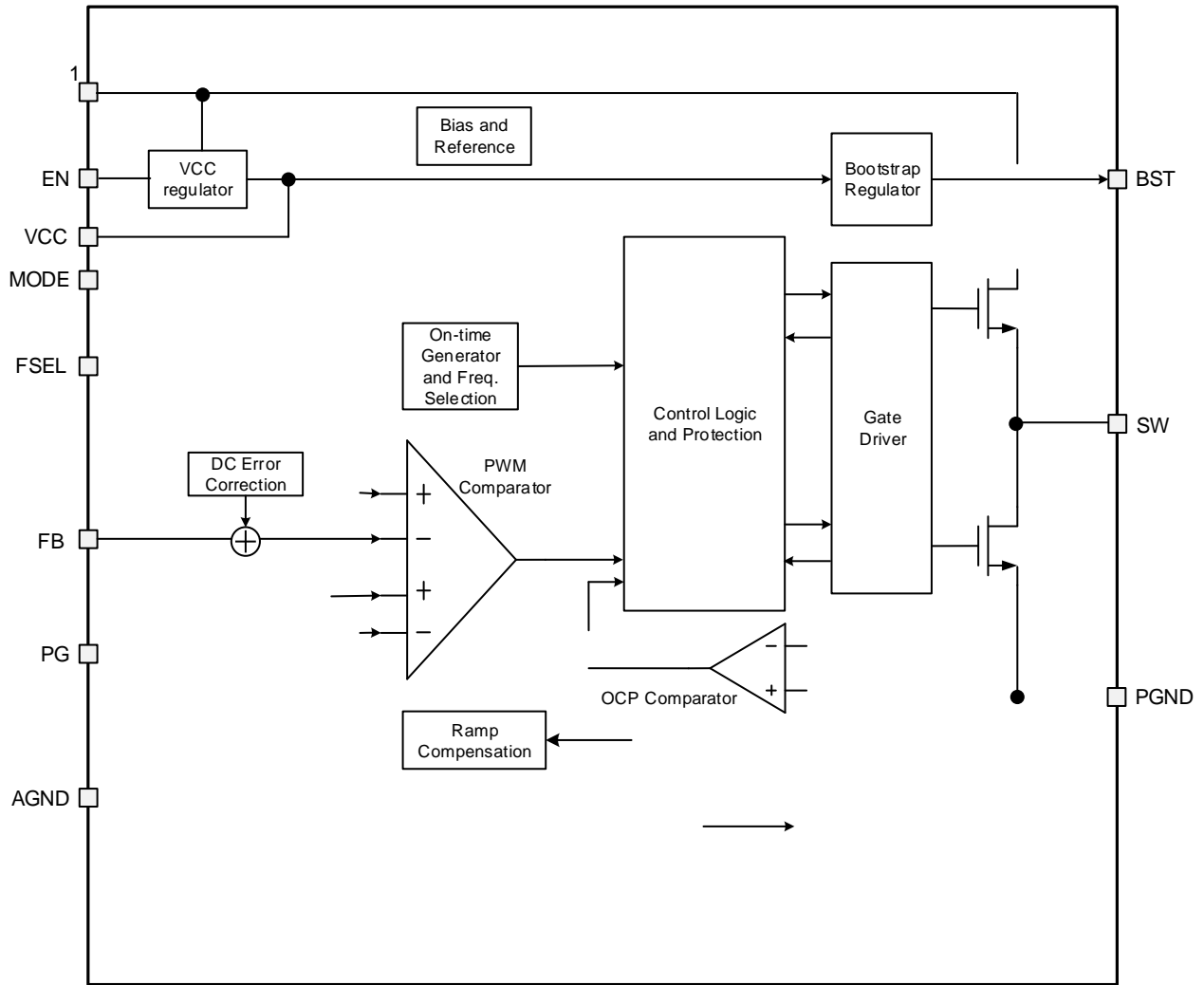

Figure 8. Functional Block Diagram



efficiency in light load is much lower than heavy load.

The SCT2260A is enabled when the VIN pin voltage rises above 4.25V and the EN pin voltage exceeds the enable threshold of 1.18V. The device is disabled when the VIN pin voltage falls below 3.98V or when the EN pin voltage is below 1.1V. An internal 1.5uA pull up current source to EN pin allows the device enable when EN pin floats.

EN pin is a high voltage pin that can be connected to VIN directly to start up the device.

For a higher system UVLO threshold, connect an external resistor divider (R1 and R2) shown in Figure 9 from VIN to EN. The UVLO rising and falling threshold can be calculated by Equation 1 and Equation 2 respectively.

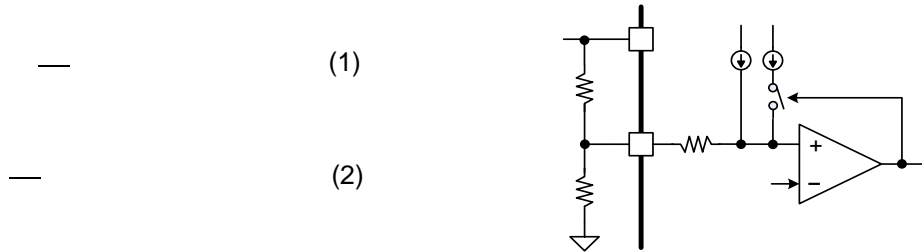

Figure 9. System UVLO by enable divide

where

V_{rise} is rising threshold of Vin UVLO

V_{fall} is falling threshold of Vin UVLO

The SCT2260A regulates the internal reference voltage at 0.6V with 1% tolerance over the operating temperature and voltage range. The output voltage is set by a resistor divider from the output node to the FB pin. It is recommended to use 1% tolerance or better resistors. Use Equation 3 to calculate resistance of resistor dividers. To improve efficiency at light loads, larger value resistors are recommended. However, if the values are too high, the

FSEL Set-up	Connect to GND	Floating	Connect to VCC
Switching Frequency	400KHz	800KHz	1200KHz

The SCT2260A features three different operation modes at light load by easily programming the MODE pin. The programming information is listed in following table. The mode setting is latched in at each power up and is not be able to be modified during operation. Cycling the input power or the EN pin can reselect the switching frequency.

MODE Set-up	Floating	Connect to GND	Connect to VCC
Switching Frequency	PFM with USM	PFM	FCCM

The Power Good (PG) pin is the output of an open drain output. When the FB pin is typically between 95% and 105% of V_{REF} the PG is de-asserted and floats after a 500 μ s de-glitch time. A pull-up resistor of 10 k Ω to 100 k Ω is recommended to pull it up to VCC. The PGOOD pin is pulled low when the FB pin voltage falls under 85% or rises over 115% of V_{REF} , including UVP and OVP; or, in an event of thermal shutdown or during the soft-start period.

An external bootstrap capacitor between BOOT pin and SW pin powers the floating gate driver to high-side power MOSFET. The bootstrap capacitor voltage is charged from 5V VCC power when high-side power MOSFET is off and low-side power MOSFET is on.

The output over-current limit (OCL) is implemented in SCT2260A by using a cycle-by-cycle valley detect control circuit. The switch current is monitored during the OFF state of the high-side FET (Q1) by measuring the low-side FET(Q2) drain to source voltage. This voltage is proportional to the switch current. During the on time of the high-side FET switch, the switch current increases at a linear rate determined by input voltage, output voltage, the on-time and the output inductor value. During the on time of the low-side FET switch, this current decrease linearly. The average value of the switch current is the load current IOUT.

If the measured drain to source voltage of the low-side FET is above the voltage proportional to current limit, the low side FET stays on until the current level becomes lower than the OCL level which reduces the output current available. In this type of valley detect control the load current is higher than the OCL threshold by one half of the peak to peak inductor ripple current. When the current is limited, the output voltage tends to drop because the load demand is higher than what the converter can support. After soft start end with 1ms waiting time, when the output voltage falls below 75% of the target voltage, the UVP comparator detects it and shuts down the device immediately, the device re-starts after a hiccup time of 7ms. When the overcurrent condition is removed, the output voltage returns to the regulated value.

The $t_{q,t}$ M i r,

The SCT2260A implements the Over-voltage Protection (OVP) circuitry to minimize output voltage overshoot during load transient, recovering from output fault condition or light load transient. The overvoltage comparator

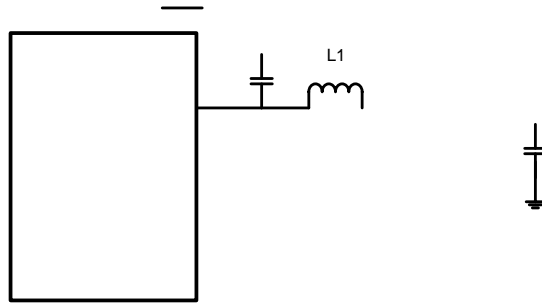

Figure 10. SCT2260A Design Example, 1V Output

Input Voltage	12V Normal 4.5V to 18V
Output Voltage	1V
Maximum Output Current	6 A
Switching Frequency	800 KHz
Output voltage ripple (peak to peak)	60mV

For good input voltage filtering, choose low-ESR ceramic capacitors. A ceramic capacitor 10 μ F is recommended for the decoupling capacitor and a 0.1 μ F ceramic bypass capacitor is recommended to be placed as close as possible to the VIN pin of the SCT2260A.

Use Equation 4

The selection of output capacitor will affect output voltage ripple in steady state and load transient performance.

The output ripple is essentially composed of two parts. One is caused by the inductor current ripple going through the Equivalent Series Resistance ESR of the output capacitors and the other is caused by the inductor current ripple charging and discharging the output capacitors. To achieve small output voltage ripple, choose a low-ESR output capacitor like ceramic capacitor. For ceramic capacitors, the capacitance dominates the output ripple. For simplification, the output voltage ripple can be estimated by Equation 7 desired.

$$\Delta V_{OUT} = \frac{V_{IN} \cdot I_{OUT}}{C_{OUT} \cdot f_{SW}} \quad (7)$$

Where

- ΔV_{OUT} is the output voltage ripple
- f_{SW} is the switching frequency
- L is the inductance of inductor
- C_{OUT} is the output capacitance
- V_{OUT} is the output voltage
- V_{IN} is the input voltage

Due to capacitor's degrading under DC bias, the bias voltage can significantly reduce capacitance. Ceramic capacitors can lose most of their capacitance at rated voltage. Therefore, leave margin on the voltage rating to ensure adequate effective capacitance. Typically, four 22μF ceramic output capacitors work for most applications.

The SCT2260A features external programmable output voltage by using a resistor divider network R1 and R2 as shown in the typical application circuit Figure10. Use equation 8 to calculate the resistor divider values.

$$R2 = \frac{V_{OUT} \cdot R1}{V_{IN} - V_{OUT}} \quad (8)$$

400	1.0	0.68	6.8	10.2	N/A
	3.3	2.2	45.9	10.2	100
	5.0	3.3	75.0	10.2	220
800	1.0	0.56	6.8	10.2	N/A
	3.3	1.5	45.9	10.2	100
	5.0	2.2	75.0	10.2	220
1200	1.0	0.47	6.8	10.2	N/A
	3.3	1.2	45.9	10.2	100
	5.0	1.5	75.0	10.2	220

Unless otherwise noted, the following conditions are VIN=12V, VOUT=1V, Temperature=25C.

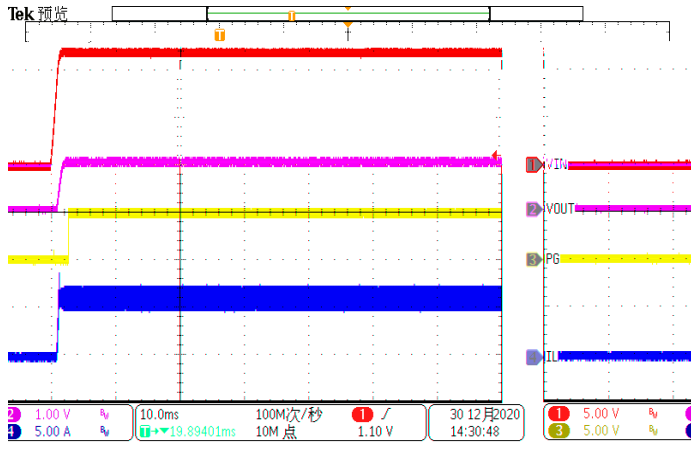

Figure 11. Power up

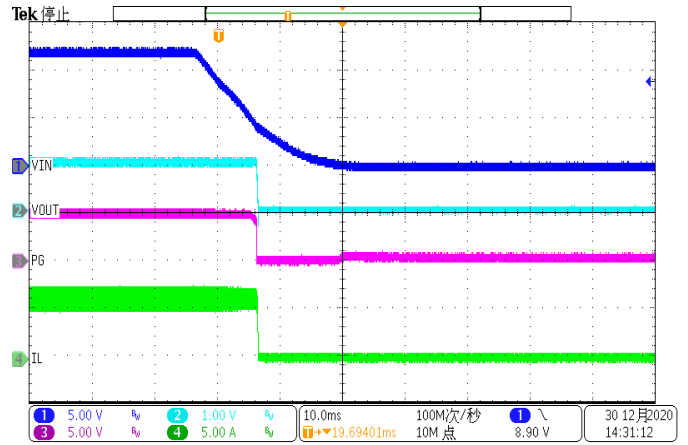

Figure 12. Power down

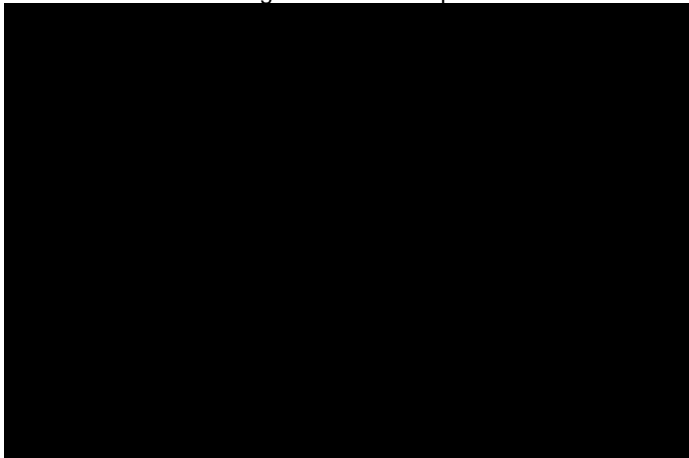

Figure 13. EN toggle (Iload=6A)

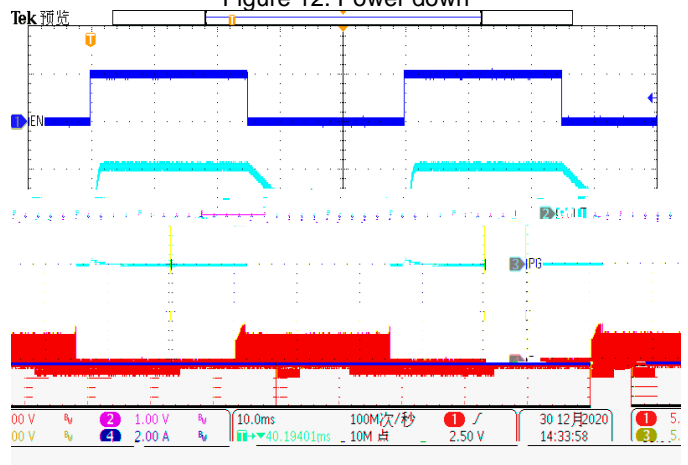

Figure 14. EN toggle (Iload=10mA)

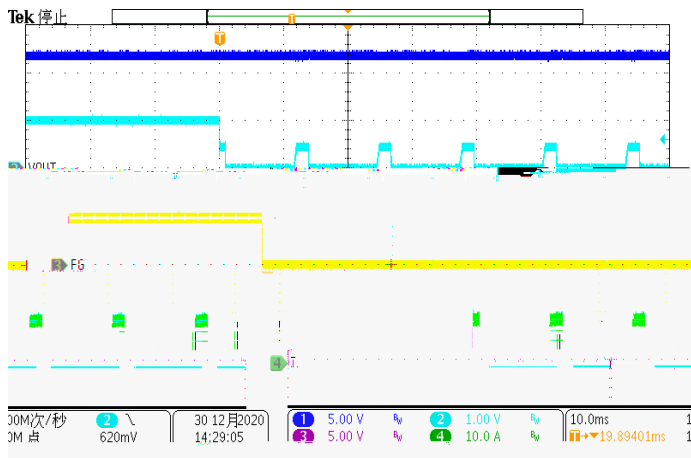

Figure 15. Over Current Protection(1A to hard short)

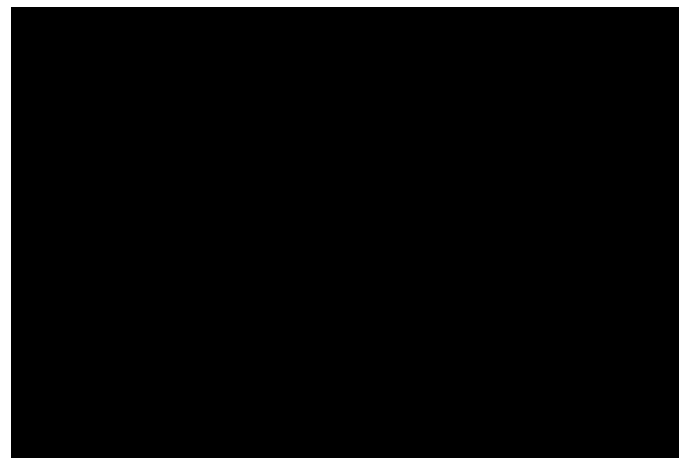

Figure 16. Over Current Release (hard short to 1A)

Unless otherwise noted, the following conditions are VIN=12V, VOUT=1V, Temperature=25C.

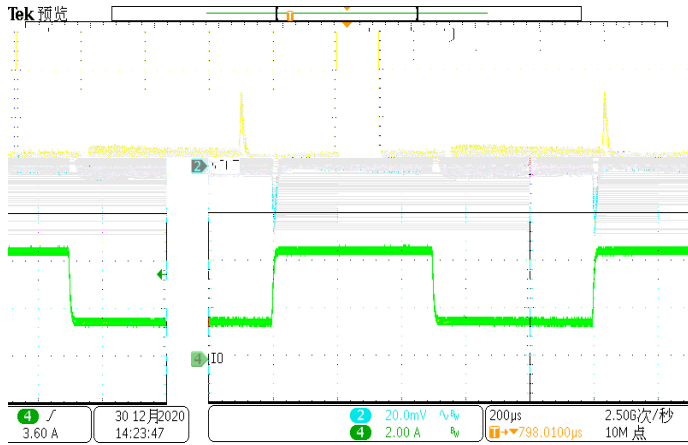

Figure 17. Load Transient (1.5A-4.5A, 1.6A/us)

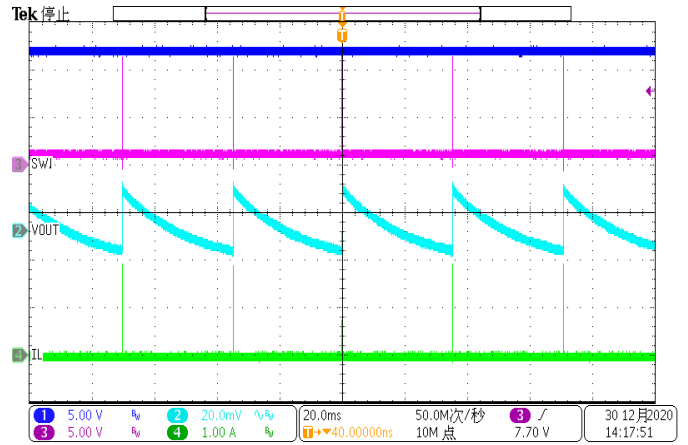

Figure 18. Output Ripple (Iload=0A, PFM)

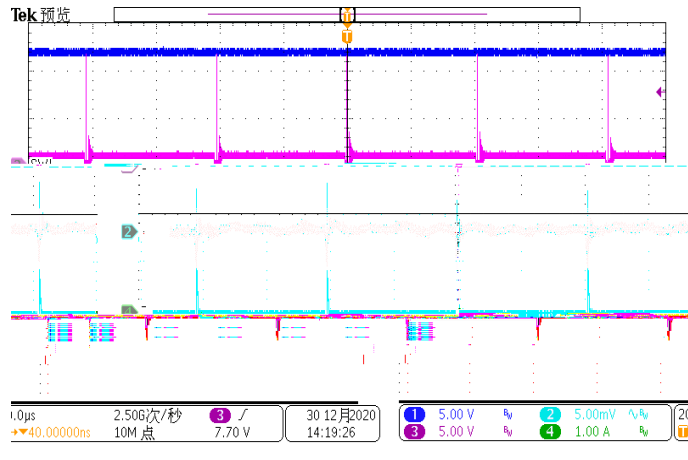

Figure 19. Output Ripple (Iload=0A, USM)

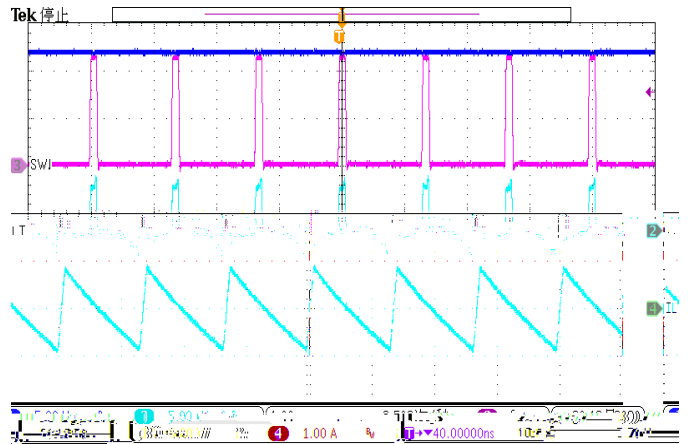

Figure 20. Output Ripple (Iload=0A, FPWM)

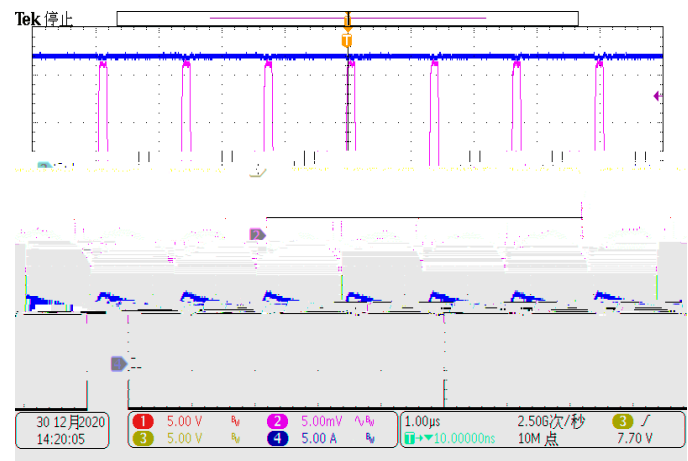

Figure 21. Output Ripple (Iload=6A)

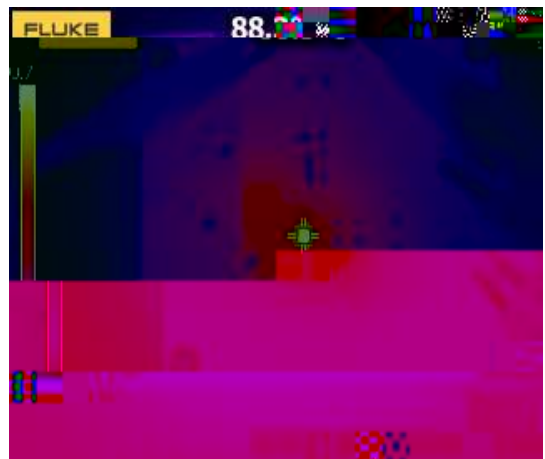
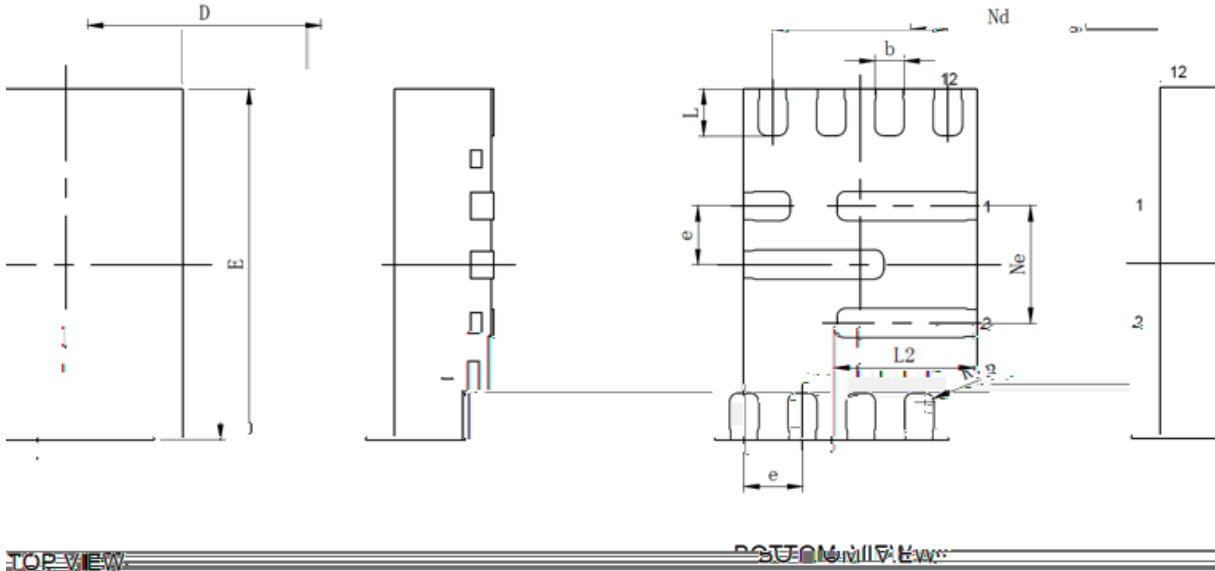

Figure 22. Thermal, 12 VIN, 1 Vout, 6A



SIDE VIEW

	0.80	0.85	0.90
	0	0.02	0.05
	0.20	0.25	0.30
	0.15	0.20	0.25
	1.95	2.00	2.05
		0.50BSC	
		1.50BSC	
		1.00BSC	
	2.95	3.00	3.05
	0.35	0.40	0.45
	1.15	1.20	1.25
		0.075REF	

1. Drawing proposed to be made a JEDEC package outline MO-220 variation.
2. Drawing not to scale.
3. Thermal pad shall be soldered on the board.
4. Dimensions of exposed pad on bottom of package do not include mold flash.
5. Contact PCB board fabrication for minimum solder mask web tolerances between the pins.



